

Port Size
603: Rc3/8 (10A)
604: Rc1/2 (15A)

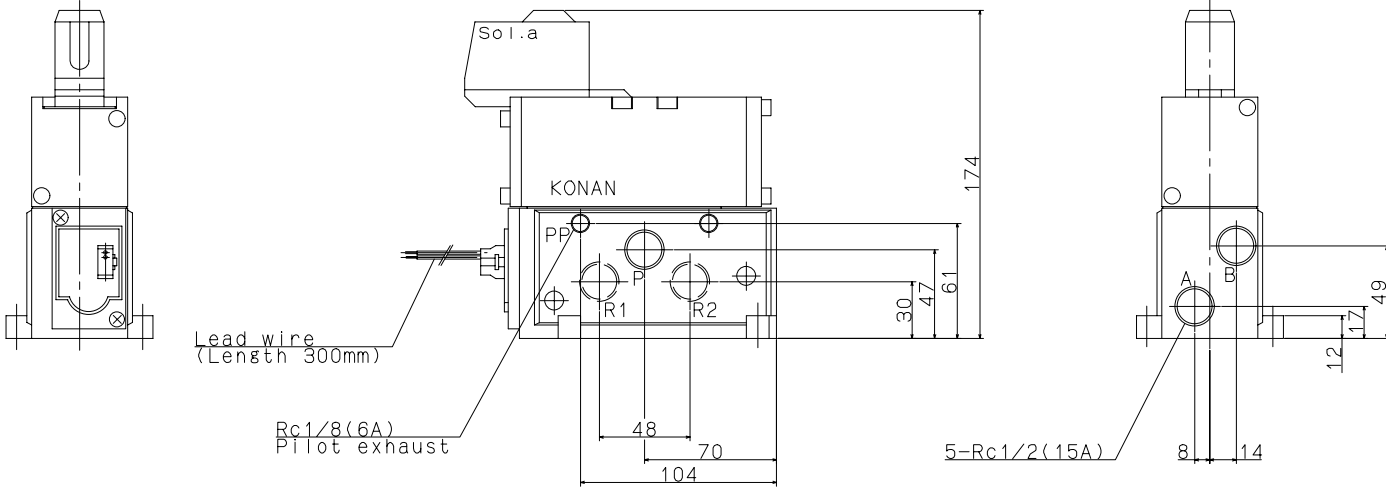
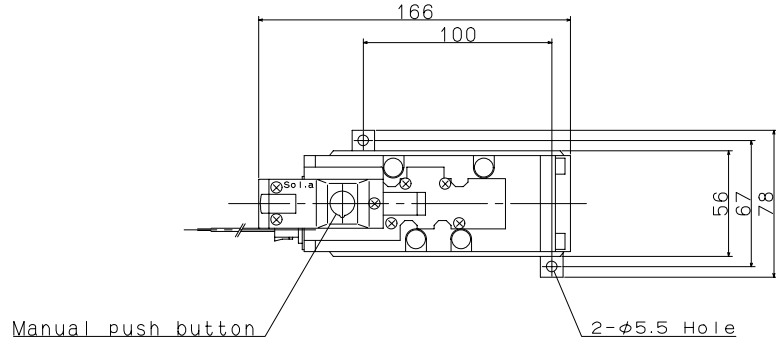

JIS Symbol
Model:
416S603E-F 414S603C-F 416S604E-F 414S604C-F
Maker:
KONAN
File Name:
414S604C-F